



BoseKnives

WILFRED WORKS

1999-2000

Tony and Reese Bose
7252 North County Road 300 East
Shelburn, Indiana 47879
812-397-5114

No. 1

SaddleHorn

2 blades - 4 1/4" or 4 5/8" closed
also available in single blade

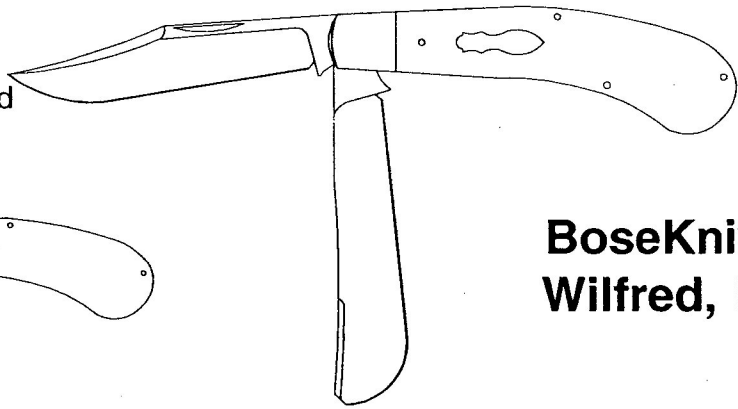

**BoseKnives
Wilfred, Ind.**

No. 2

SaddleHorn

2 blades - 3 1/2" closed
also available in single blade

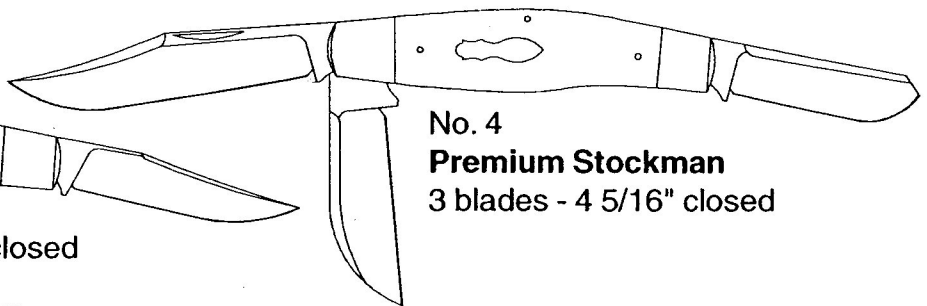
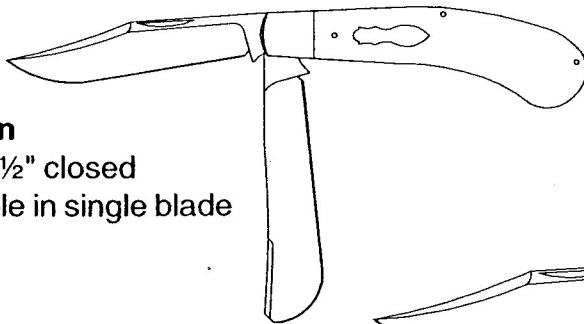

No. 4

Premium Stockman

3 blades - 4 5/16" closed



No. 5 **MuskRat**

2 blades - 3 7/8" closed

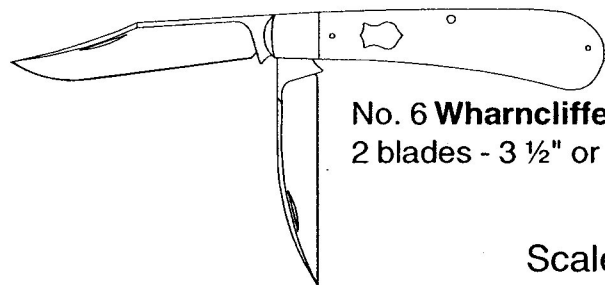

No. 6 **Wharnccliffe Trapper**

2 blades - 3 1/2" or 3" closed



No. 8 **Gent's Knife, Wharnccliffe**

1 blade - 3" closed

Scale: 1/2"=1"



No. 9 **Gent's Knife, Clip**

1 blade - 3" closed

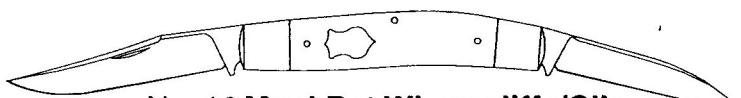

No. 10 **MuskRat Wharnccliffe/Clip**

2 blades - 3 1/4" closed

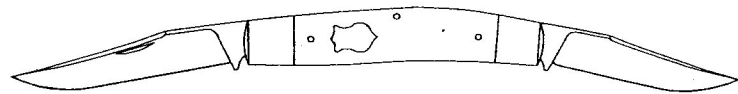

No. 11 **MuskRat Double Rat Blades**

2 blades - 3 1/4" closed

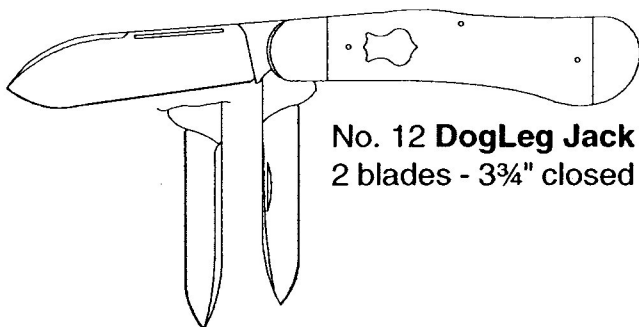

No. 12 **DogLeg Jack**

2 blades - 3 3/4" closed

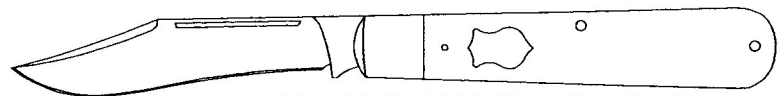

No. 13 **R-1143 Regular Jack**

1 blades - 4 3/8" closed

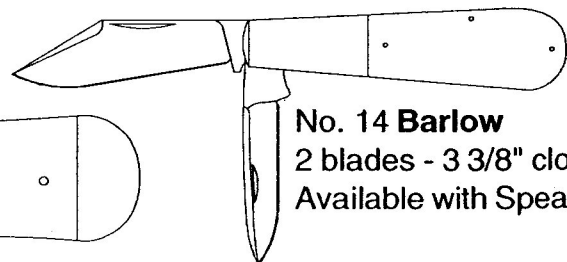

No. 14 **Barlow**

2 blades - 3 3/8" closed

Available with Spear Master

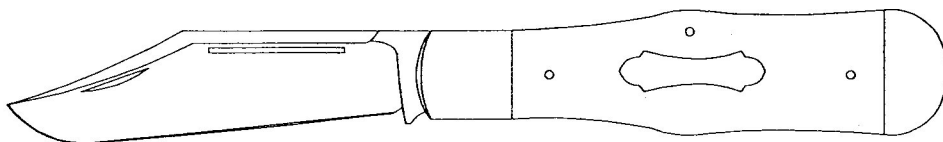

No. 17 **Coke Bottle**

1 blade - 5 1/2" closed

also available in 2 blades

No. 18 Sleeveboard Whittler
3 blades - 3 3/4" closed

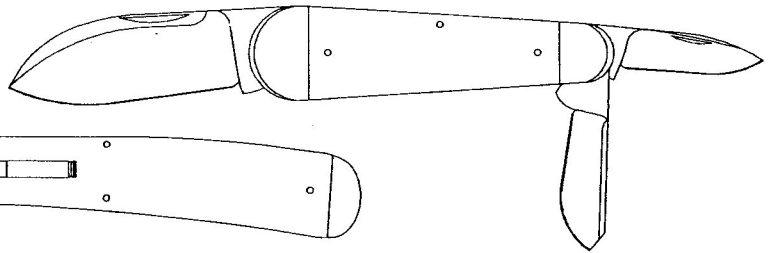

**BoseKnives
Wilfred, Ind.**

Scale: 1/2"=1"

No. 19 R-293 Hunter-Trader-Trapper
2 blades - 5 3/8" or 4" closed

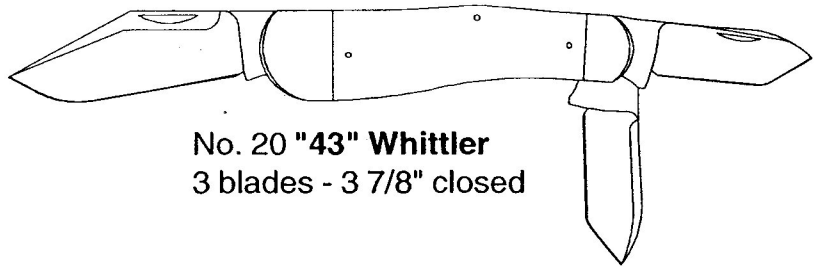
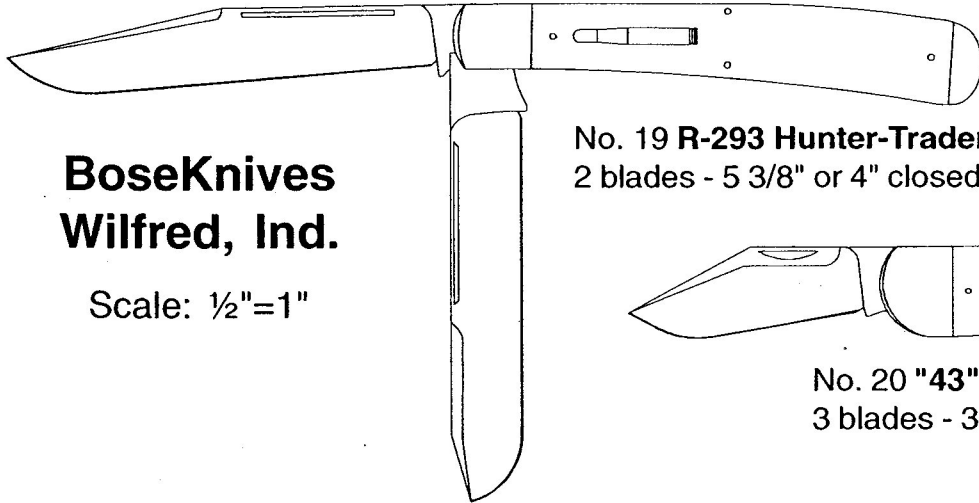

No. 20 "43" Whittler
3 blades - 3 7/8" closed

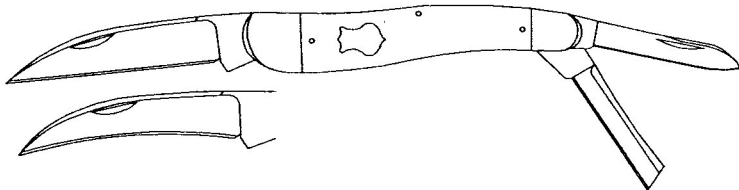

No. 21 Rodgers Wharncliffe Whittler
3 blades - 3 1/2" closed

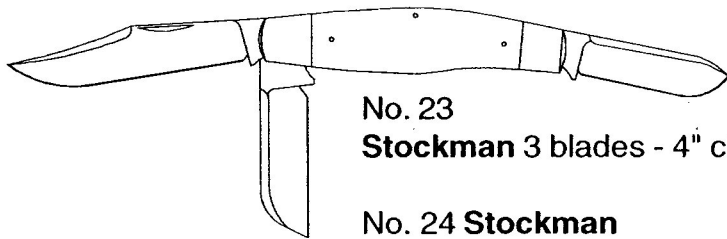

No. 23
Stockman 3 blades - 4" closed

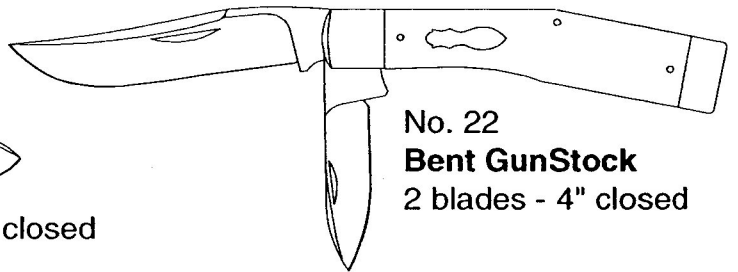

No. 22
Bent GunStock
2 blades - 4" closed

No. 24 Stockman
3 blades - 3 1/8" closed

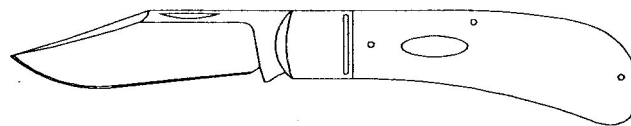

No. 26 Lanny's Clip
1 blade - 3 3/4" closed

No. 27
R-1123 Remington Bullet
2 blades - 4 1/2" closed

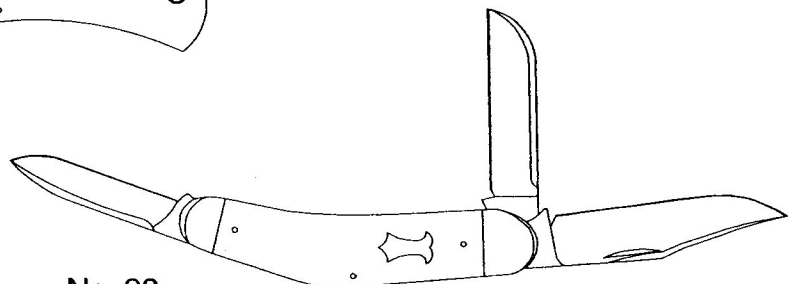
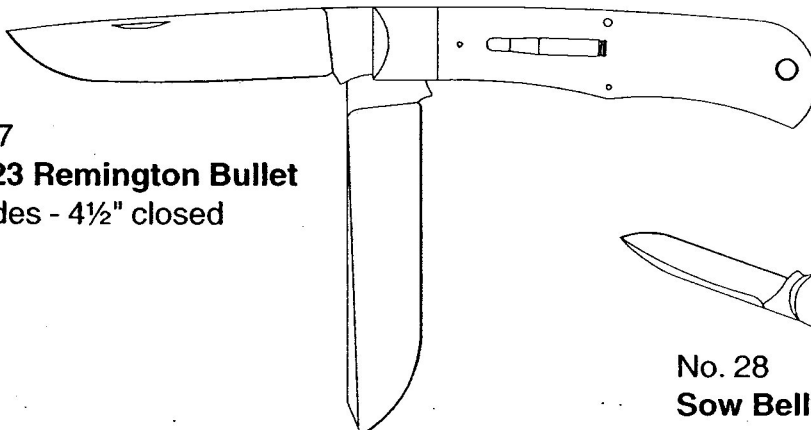

No. 28
Sow Belly
3 blades - 3 3/4" closed

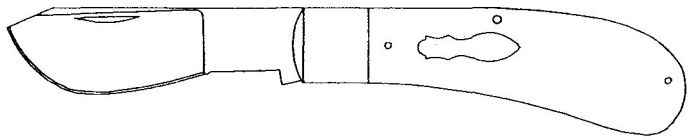

No. 29 Cotton Sampler's Knife
Single blade - 4 1/8" closed

No. 31 Congress
4 blades - 3 1/2" closed or 4 1/4" closed

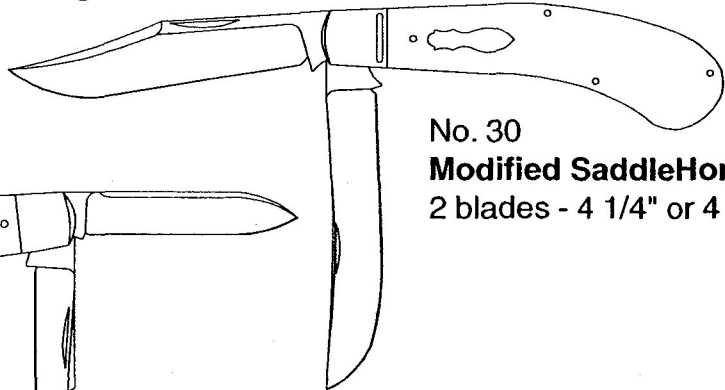
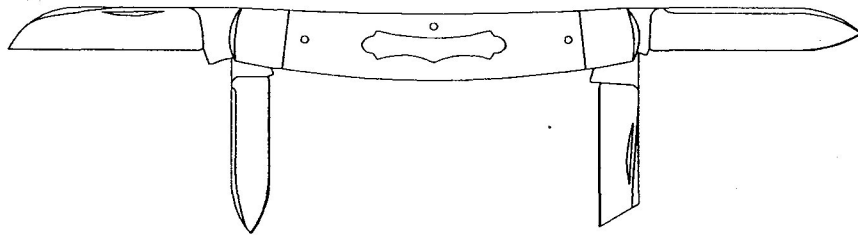

No. 30 Modified SaddleHorn
2 blades - 4 1/4" or 4 5/8" closed

No. 32 Swayback Jack
2 blades - 3 1/8 or 3 1/2" closed

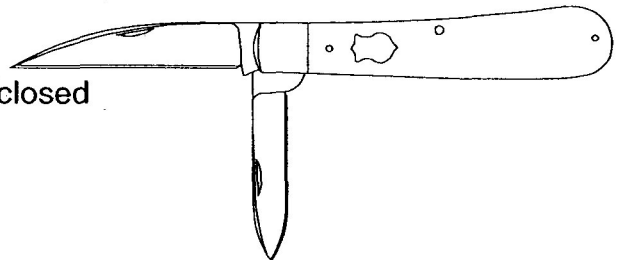

No. 33 Coffin Jack
2 blades - 3 1/2" closed

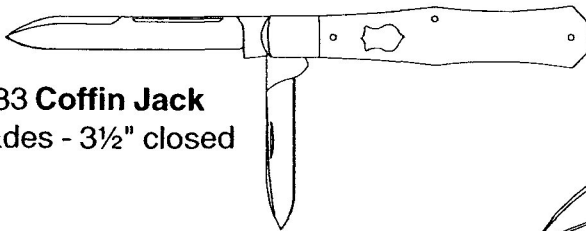

No. 34 Gardener's Knife
Single blade - 3 7/8" closed

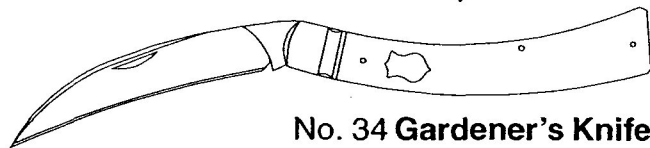

No. 35 GunStock
2 blades - 3 1/4" closed

No. 36 Congress Whittler
3 blades - 3 1/2" closed

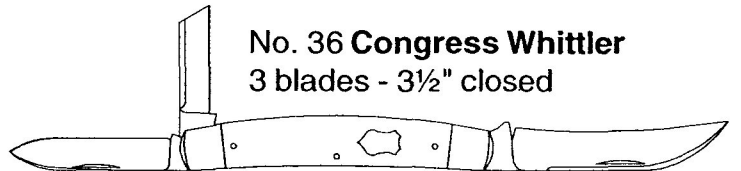
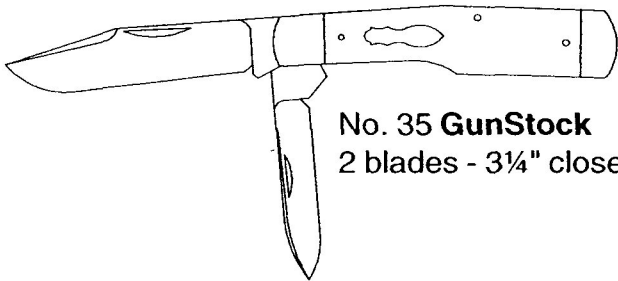

No. 37 R-1263 Remington Bullet
2 blades - 5 3/8" or 4" closed

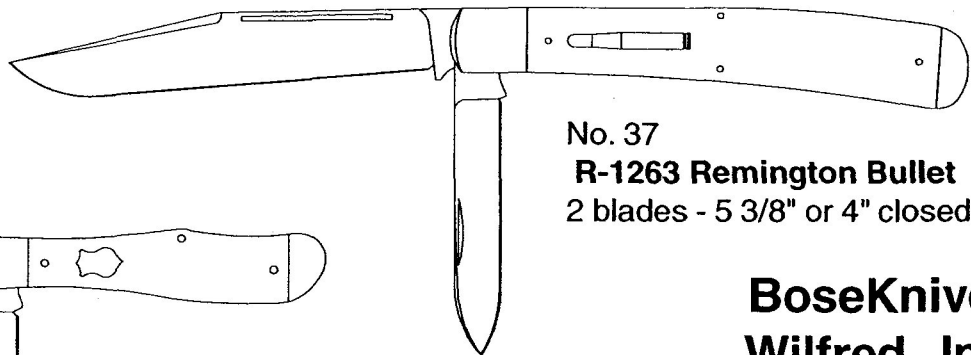

No. 38 Eureka Jack
2 blades - 3 1/2" closed

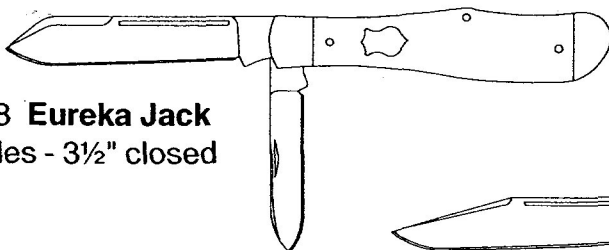

**BoseKnives
Wilfred, Ind.**

No. 39 Moose
2 blades - 4" closed

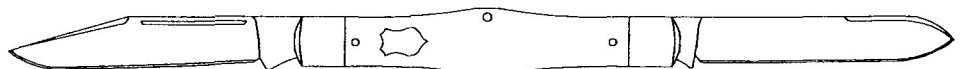

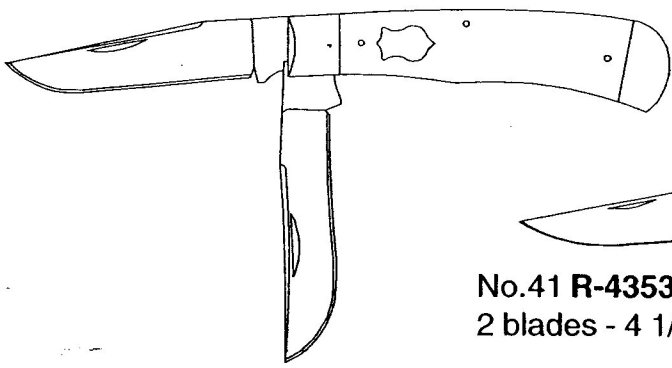

No.40 New Millennium Trapper
2 blades - 4" closed

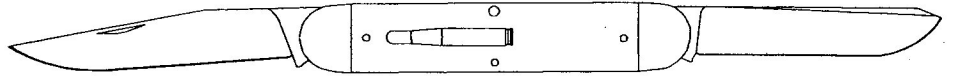

No.41 R-4353 Bullet
2 blades - 4 1/4" closed

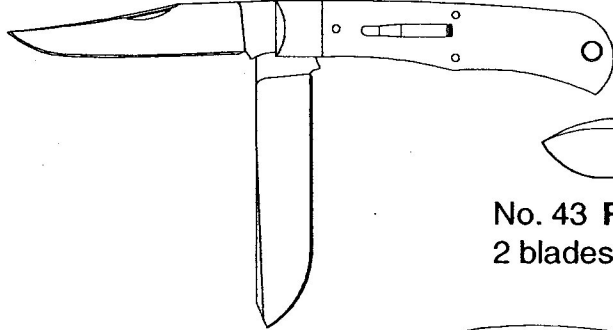

No.42 R-1173 Bullet
2 blades - 3 1/2" closed

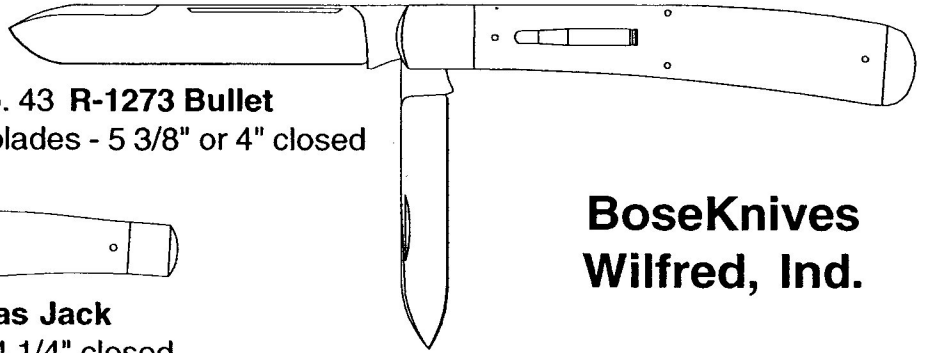

No. 43 R-1273 Bullet
2 blades - 5 3/8" or 4" closed

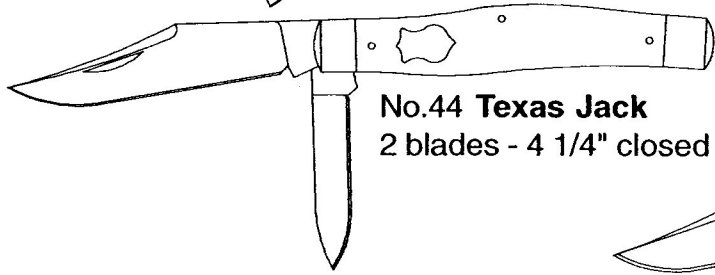

No.44 Texas Jack
2 blades - 4 1/4" closed

**BoseKnives
Wilfred, Ind.**

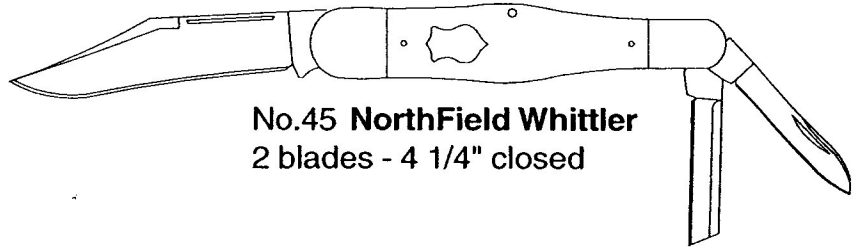

No.45 NorthField Whittler
2 blades - 4 1/4" closed